

PS X2 Precision Balances

Advanced weighing under laboratory and less challenging industrial conditions



PS X2, d = 1 mg



PS X2, d = 10 mg

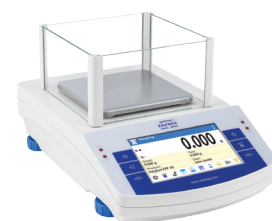

Glass draft shield for PS 3000.X2 balance



PS X2, d = 10 mg, Max > 6000 g

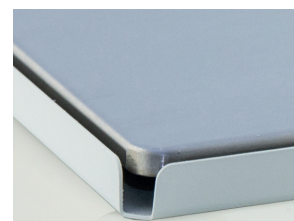

Single-point support for balance with Max > 6000 g

Functions

- | | | | | |
|----------------|------------------|-----------------------|-------------------|--------------------------------|
| Parts counting | Percent weighing | Density determination | Peak hold | Ambient conditions measurement |
| Dosing | Statistics | Under hook weighing | GLP procedures | Replaceable unit |
| Checkweighing | Animal weighing | Autotest | Proximity sensors | Multilingual menu |
| Formulations | | | | |

Features

Reliable Results and High Measurement Precision

Excellent measurement parameters and performance enable applying PS X2 balances in laboratories and various branches of industry.

Weighing Heavy Loads with the Maximum Accuracy

Due to an exceptionally wide range of capacities it is possible to work with samples of different weight, from few grams to even over one hundred kilograms.

Ease of Use and Maximum Comfort of Operation

Thanks to a clear and intuitive menu layout and 5" colour touch screen, maximum comfort and incredibly easy operation are both ensured.

Customization via Widgets

PS X2 software enables designing screen widgets layout. Display customization allows you to run any selected function directly from the home screen.

Automatic Adjustment

Internal adjustment system guarantees the highest accuracy and reliable measurements results.

Touch-Free Operation

Two programmable proximity sensors can be assigned with any function or application. The given function when assigned is both run and operated touch-free.

Numerous Options of Data Management

The instrument enables saving all data of carried out measurements as reports and graphs.

Technical Specifications

	PS 200/2000.X2	PS 210.X2	PS 360.X2
Maximum capacity [Max]	200 g / 2000 g	210 g	360 g
Minimum load	0.02 g	0.02 g	0.02 g
Readability [d]	0.001 g / 0.01 g	0.001 g	0.001 g
Verification scale interval [e]	0.01 g / 0.1 g	0.01 g	0.01 g
Tare range	- 2000 g	- 210 g	- 360 g
Repeatability*	0.001 g / 0.01 g	0.001 g	0.001 g
Linearity	±0.002 g / ±0.02 g	±0.002 g	±0.002 g
Sensitivity temperature drift**	$2 \times 10^{-6} / ^\circ\text{C} \times \text{Rt}$	$2 \times 10^{-6} / ^\circ\text{C} \times \text{Rt}$	$2 \times 10^{-6} / ^\circ\text{C} \times \text{Rt}$
Minimum weight (U=1%, k=2)	0.1 g	0.1 g	0.1 g
Minimum weight (USP)	1 g	1 g	1 g
Stabilization time	2 s / 1.5 s	2 s	2 s
Adjustment	internal	internal	internal
Verification	Yes	Yes	Yes
OIML Class	II	II	II
Display	5" capacitive colour touch screen	5" capacitive colour touch screen	5" capacitive colour touch screen
Keypad	6 keys	6 keys	6 keys
Protection class	IP 43	IP 43	IP 43
Databases	7	7	7
Touch-free operation	2 programmable proximity sensors	2 programmable proximity sensors	2 programmable proximity sensors
USB-A	1	1	1
USB-B	1	1	1
RS 232	2	2	2
Wireless connection	802.11 b/g/n	802.11 b/g/n	802.11 b/g/n
IN/OUT	10 / 100 Mbit	10 / 100 Mbit	10 / 100 Mbit
Power supply	12 ÷ 16 V DC	12 ÷ 16 V DC	12 ÷ 16 V DC
Power consumption	4 W	4 W	4 W
Operating temperature	+10 ÷ +40 °C	+10 ÷ +40 °C	+10 ÷ +40 °C
Atmospheric humidity***	40 ÷ 80%	40 ÷ 80%	40 ÷ 80%
Transport and storage temperature	-20 ÷ +50 °C	-20 ÷ +50 °C	-20 ÷ +50 °C
Weighing pan dimensions	128 × 128 mm	128 × 128 mm	128 × 128 mm
Weighing device dimensions	333 × 206 × 100 mm	333 × 206 × 100 mm	333 × 206 × 100 mm
Net weight	3.9 kg	3.7 kg	3.7 kg
Gross weight	5.5 kg	5.3 kg	5.3 kg
Packaging dimensions	470 × 380 × 340 mm	470 × 380 × 336 mm	470 × 380 × 340 mm

Rt net weight

* repeatability is expressed as a standard deviation from 10 weighing cycles

** parameter determined in the following temperature range: +15 ÷ +35 °C

*** non-condensing conditions

In accordance with type approval, the balance parameters are maintained in temperature range: +15 ÷ +35 °C.

	PS 600.X2	PS 750.X2	PS 1000.X2	PS 3000.X2
Maximum capacity [Max]	600 g	750 g	1000 g	3000 g
Minimum load	0.02 g	0.02 g	0.02 g	0.02 g
Readability [d]	0.001 g	0.001 g	0.001 g	0.001 g
Verification scale interval [e]	0.01 g	0.01 g	0.01 g	—
Tare range	-600 g	-750 g	-1000 g	-3000 g
Repeatability*	0.0015 g	0.0015 g	0.0015 g	0.0015 g
Linearity	±0.003 g	±0.003 g	±0.003 g	±0.004 g
Sensitivity temperature drift**	$2 \times 10^{-6} / ^\circ\text{C} \times R_t$	$2 \times 10^{-6} / ^\circ\text{C} \times R_t$	$2 \times 10^{-6} / ^\circ\text{C} \times R_t$	$2 \times 10^{-6} / ^\circ\text{C} \times R_t$
Minimum weight (U=1%, k=2)	0.1 g	0.1 g	0.1 g	0.1 g
Minimum weight (USP)	1 g	1 g	1 g	1 g
Stabilization time	2 s	2 s	2 s	3 s
Adjustment	internal	internal	internal	internal
Verification	Yes	Yes	Yes	—
OIML Class	II	II	II	—
Display	5" capacitive colour touch screen	5" capacitive colour touch screen	5" capacitive colour touch screen	5" capacitive colour touch screen
Keypad	6 keys	6 keys	6 keys	6 keys
Protection class	IP 43	IP 43	IP 43	IP 43
Databases	7	7	7	7
Touch-free operation	2 programmable proximity sensors	2 programmable proximity sensors	2 programmable proximity sensors	2 programmable proximity sensors
USB-A	1	1	1	1
USB-B	1	1	1	1
RS 232	2	2	2	2
Wireless connection	802.11 b/g/n	802.11 b/g/n	802.11 b/g/n	802.11 b/g/n
IN/OUT	10 / 100 Mbit	10 / 100 Mbit	10 / 100 Mbit	10 / 100 Mbit
Power supply	12 ÷ 16 V DC	12 ÷ 16 V DC	12 ÷ 16 V DC	12 ÷ 16 V DC
Power consumption	4 W	4 W	4 W	4 W
Operating temperature	+10 ÷ +40 °C	+10 ÷ +40 °C	+10 ÷ +40 °C	+10 ÷ +40 °C
Atmospheric humidity***	40 ÷ 80%	40 ÷ 80%	40 ÷ 80%	40 ÷ 80%
Transport and storage temperature	-20 ÷ +50 °C	-20 ÷ +50 °C	-20 ÷ +50 °C	-20 ÷ +50 °C
Weighing pan dimensions	128 × 128 mm	128 × 128 mm	128 × 128 mm	128 × 128 mm
Weighing device dimensions	333 × 206 × 100 mm	333 × 206 × 100 mm	333 × 206 × 100 mm	333 × 206 × 100 mm
Net weight	3.9 kg	3.9 kg	3.9 kg	3.9 kg
Gross weight	5.5 kg	5.5 kg	5.5 kg	5.5 kg
Packaging dimensions	470 × 380 × 340 mm	470 × 380 × 340 mm	470 × 380 × 340 mm	470 × 380 × 340 mm

Rt net weight

* repeatability is expressed as a standard deviation from 10 weighing cycles

** parameter determined in the following temperature range: +15 ÷ +35 °C

*** non-condensing conditions

In accordance with type approval, the balance parameters are maintained in temperature range: +15 ÷ +35 °C.

	PS 1200.X2	PS 2100.X2	PS 3500.X2
Maximum capacity [Max]	1200 g	2100 g	3500 g
Minimum load	0.5 g	0.5 g	0.5 g
Readability [d]	0.01 g	0.01 g	0.01 g
Verification scale interval [e]	0.1 g	0.1 g	0.1 g
Tare range	-1200 g	-2100 g	-3500 g
Repeatability*	0.01 g	0.01 g	0.01 g
Linearity	±0.02 g	±0.02 g	±0.02 g
Sensitivity temperature drift**	$2 \times 10^{-6} / ^\circ\text{C} \times R_t$	$2 \times 10^{-6} / ^\circ\text{C} \times R_t$	$2 \times 10^{-6} / ^\circ\text{C} \times R_t$
Minimum weight (U=1%, k=2)	1 g	1 g	1 g
Minimum weight (USP)	10 g	10 g	10 g
Stabilization time	1.5 s	1.5 s	1.5 s
Adjustment	internal	internal	internal
Verification	Yes	Yes	Yes
OIML Class	II	II	II
Display	5" capacitive colour touch screen	5" capacitive colour touch screen	5" capacitive colour touch screen
Keypad	6 keys	6 keys	6 keys
Protection class	IP 43	IP 43	IP 43
Databases	7	7	7
Touch-free operation	2 programmable proximity sensors	2 programmable proximity sensors	2 programmable proximity sensors
USB-A	1	1	1
USB-B	1	1	1
RS 232	2	2	2
Wireless connection	802.11 b/g/n	802.11 b/g/n	802.11 b/g/n
IN/OUT	10 / 100 Mbit	10 / 100 Mbit	10 / 100 Mbit
Power supply	12 ÷ 16 V DC	12 ÷ 16 V DC	12 ÷ 16 V DC
Power consumption	4 W	4 W	4 W
Operating temperature	+10 ÷ +40 °C	+10 ÷ +40 °C	+10 ÷ +40 °C
Atmospheric humidity***	40 ÷ 80%	40 ÷ 80%	40 ÷ 80%
Transport and storage temperature	-20 ÷ +50 °C	-20 ÷ +50 °C	-20 ÷ +50 °C
Weighing pan dimensions	195 × 195 mm	195 × 195 mm	195 × 195 mm
Weighing device dimensions	333 × 206 × 100 mm	333 × 206 × 100 mm	333 × 206 × 100 mm
Net weight	4.3 kg	4.3 kg	4.5 kg
Gross weight	5.8 kg	5.8 kg	6 kg
Packaging dimensions	470 × 380 × 340 mm	470 × 380 × 340 mm	470 × 380 × 340 mm

Rt net weight

* repeatability is expressed as a standard deviation from 10 weighing cycles

** parameter determined in the following temperature range: +15 ÷ +35 °C

*** non-condensing conditions

In accordance with type approval, the balance parameters are maintained in temperature range: +15 ÷ +35 °C.

	PS 4500.X2	PS 6000.X2	PS 6001.X2
Maximum capacity [Max]	4500 g	6000 g	6000 g
Minimum load	0.5 g	0.5 g	0.5 g
Readability [d]	0.01 g	0.01 g	0.1 g
Verification scale interval [e]	0.1 g	0.1 g	0.1 g
Tare range	-4500 g	-6000 g	-6000 g
Repeatability*	0.01 g	0.015 g	0.1 g
Linearity	±0.02 g	±0.03 g	±0.1 g
Sensitivity temperature drift**	$2 \times 10^{-6} / ^\circ\text{C} \times R_t$	$2 \times 10^{-6} / ^\circ\text{C} \times R_t$	$2 \times 10^{-6} / ^\circ\text{C} \times R_t$
Minimum weight (U=1%, k=2)	1 g	1 g	1 g
Minimum weight (USP)	10 g	10 g	10 g
Stabilization time	1.5 s	1.5 s	1.5 s
Adjustment	internal	internal	internal
Verification	Yes	Yes	Yes
OIML Class	II	II	II
Display	5" capacitive colour touch screen	5" capacitive colour touch screen	5" capacitive colour touch screen
Keypad	6 keys	6 keys	6 keys
Protection class	IP 43	IP 43	IP 43
Databases	7	7	7
Touch-free operation	2 programmable proximity sensors	2 programmable proximity sensors	2 programmable proximity sensors
USB-A	1	1	1
USB-B	1	1	1
RS 232	2	2	2
Wireless connection	802.11 b/g/n	802.11 b/g/n	802.11 b/g/n
IN/OUT	10 / 100 Mbit	10 / 100 Mbit	10 / 100 Mbit
Power supply	12 ÷ 16 V DC	12 ÷ 16 V DC	12 ÷ 16 V DC
Power consumption	4 W	4 W	4 W
Operating temperature	+10 ÷ +40 °C	+10 ÷ +40 °C	+10 ÷ +40 °C
Atmospheric humidity***	40 ÷ 80%	40 ÷ 80%	40 ÷ 80%
Transport and storage temperature	-20 ÷ +50 °C	-20 ÷ +50 °C	-20 ÷ +50 °C
Weighing pan dimensions	195 × 195 mm	195 × 195 mm	195 × 195 mm
Weighing device dimensions	333 × 206 × 100 mm	333 × 206 × 100 mm	333 × 206 × 100 mm
Net weight	4.5 kg	4.8 kg	4.8 kg
Gross weight	6 kg	6.4 kg	6.4 kg
Packaging dimensions	470 × 380 × 340 mm	470 × 380 × 340 mm	470 × 380 × 340 mm

Rt net weight

* repeatability is expressed as a standard deviation from 10 weighing cycles

** parameter determined in the following temperature range: +15 ÷ +35 °C

*** non-condensing conditions

In accordance with type approval, the balance parameters are maintained in temperature range: +15 ÷ +35 °C.

	PS 6100.X2	PS 8100.X2	PS 10100.X2
Maximum capacity [Max]	6100 g	8100 g	10100 g
Minimum load	0.5 g	0.5 g	0.5 g
Readability [d]	0.01 g	0.01 g	0.01 g
Verification scale interval [e]	—	—	—
Tare range	– 6100 g	– 8100 g	– 10100 g
Repeatability*	0.01 g	0.012 g	0.015 g
Linearity	±0.03 g	±0.03 g	±0.03 g
Sensitivity temperature drift**	$2 \times 10^{-6} / ^\circ\text{C} \times R_t$	$2 \times 10^{-6} / ^\circ\text{C} \times R_t$	$2 \times 10^{-6} / ^\circ\text{C} \times R_t$
Minimum weight (U=1%, k=2)	1 g	1 g	1 g
Minimum weight (USP)	10 g	10 g	10 g
Stabilization time	1.5 s	1.5 s	1.5 s
Adjustment	internal	internal	internal
Verification	—	—	—
OIML Class	—	—	—
Display	5" capacitive colour touch screen	5" capacitive colour touch screen	5" capacitive colour touch screen
Keypad	6 keys	6 keys	6 keys
Protection class	IP 43	IP 43	IP 43
Databases	7	7	7
Touch-free operation	2 programmable proximity sensors	2 programmable proximity sensors	2 programmable proximity sensors
USB-A	1	1	1
USB-B	1	1	1
RS 232	2	2	2
Wireless connection	802.11 b/g/n	802.11 b/g/n	802.11 b/g/n
IN/OUT	10 / 100 Mbit	10 / 100 Mbit	10 / 100 Mbit
Power supply	12 ÷ 16 V DC	12 ÷ 16 V DC	12 ÷ 16 V DC
Power consumption	4 W	4 W	4 W
Operating temperature	+10 ÷ +40 °C	+10 ÷ +40 °C	+10 ÷ +40 °C
Atmospheric humidity***	40 ÷ 80%	40 ÷ 80%	40 ÷ 80%
Transport and storage temperature	–20 ÷ +50 °C	–20 ÷ +50 °C	–20 ÷ +50 °C
Weighing pan dimensions	195 × 195 mm	195 × 195 mm	195 × 195 mm
Weighing device dimensions	333 × 206 × 107 mm	333 × 206 × 107 mm	333 × 206 × 107 mm
Net weight	5.7 kg	5.7 kg	5.7 kg
Gross weight	7.3 kg	7.3 kg	7.3 kg
Packaging dimensions	470 × 380 × 340 mm	470 × 380 × 340 mm	470 × 380 × 340 mm

Rt net weight

* repeatability is expressed as a standard deviation from 10 weighing cycles

** parameter determined in the following temperature range: +15 ÷ +35 °C

*** non-condensing conditions

In accordance with type approval, the balance parameters are maintained in temperature range: +15 ÷ +35 °C.

Dimensions

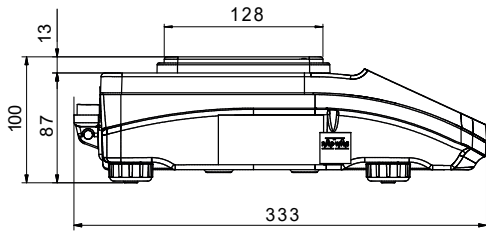

PS X2, d = 1 mg

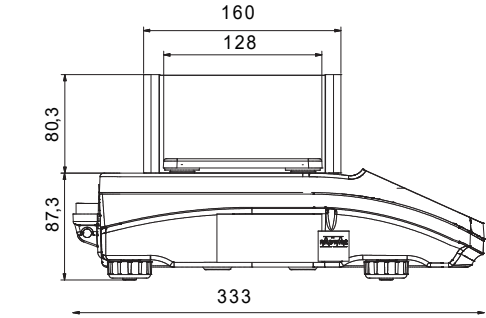
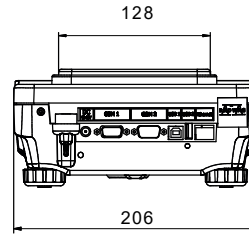

PS 3000.X2

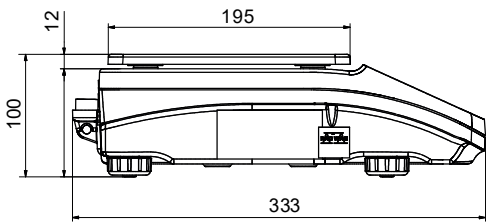
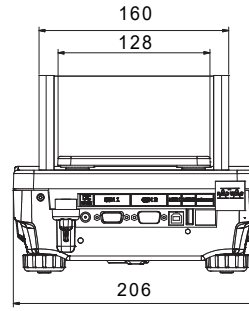

PS X2, d = 10 mg

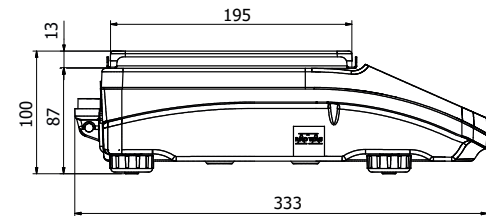
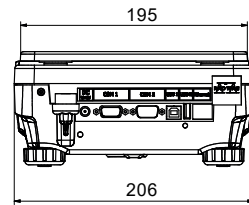

PS 6000.X2, PS 6001.X2

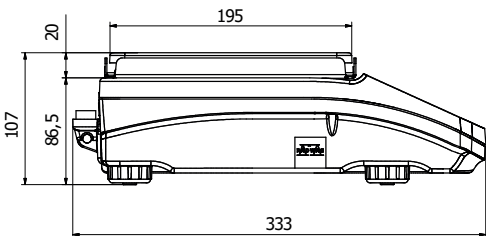
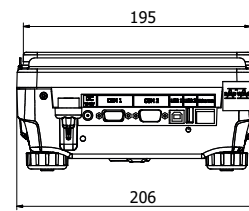

PS X2, d = 10 mg, Max ≥ 6100 g

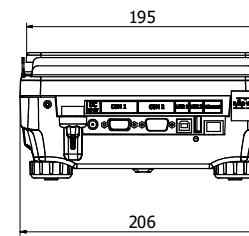

Accessories

Weighing Tables

- granite antivibration table
- antivibration tables for laboratory balances
- professional weighing table

Professional Weighing

- KIT 128 density determination kit
- KIT 195 density determination kit
- under-hook weighing rack

Ambient Conditions

- THB-X ambient conditions module

Peripheral Devices

- Epson dot matrix printer
- label printer
- receipt printer
- barcode scanners
- WD-6 LCD display

Cables, Converters

- P0108: RS 232 cable (balance-computer)
- P0151: RS 232 cable (balance - Epson printer)
- USB cable type A-B
- AP2-1 power loop output

Electrical Accessories

- ZR-02 power supply with battery

Draft Shields and Anti-Draft Chambers

- draft shield with a weighing pan 128 x 128 mm
- anti-draft chamber with a weighing pan 128 x 128 mm
- protective cover for X2 series indicator

Remaining Accessories

- suitcase for PS

Dedicated Software

R-LAB

- collecting measurements
- carrying out statistical analysis of measurements
- customized graphs and reports

E2R Weighing Records

- complete, automated databases synchronization
- fully supported processes of labelling and parts counting
- record of weighings, weighings archiving
- basic and advanced (with graphs) reports

Alibi Reader

- readout of data saved to Alibi memory
- export of data saved to Alibi memory
- data filtering and reports generating
- saving ALIBI database to CSV file

R.Barcode

- The basic function software is presentation of the data sent by barcode scanners connected to PC via USB or RS232

RAD KEY

- Establishing cooperation between a weighing instrument and a computer

Radwag Development Studio

- presentation of functions (and subfunctions) of communication protocol (Common Communication Protocol)
- possibility of connection with weighing equipment on which each

function is carried out,

- library with mass control, contained within the development environment
- complete documentation of the communication protocol
- set of user manuals for different solutions addressed for programmers employed in companies using RADWAG-manufactured weighing equipment

RADWAG Connect

- establishing communication with all balances, scales and weighing modules using Common Communication Protocol
- communication via local network,
- support of basic functions
- auto searching for devices
- connecting with few devices simultaneously, swapping between them
- clear list of connected platforms
- record of measurements in the program,
- export of carried out measurements to CSV file,
- work performed using freely selected device with Windows 10 operating system

LabView Driver

- operation of RADWAG balances in LabView environment